

Name: _____

Instructions: Look at the pictures. Colour the picture that shows "IN" blue and the picture that shows **OUT** in red.

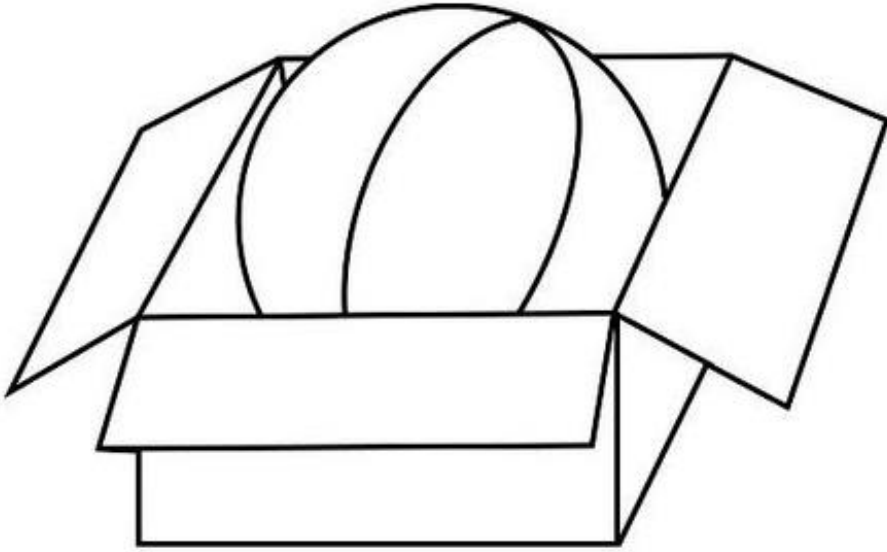
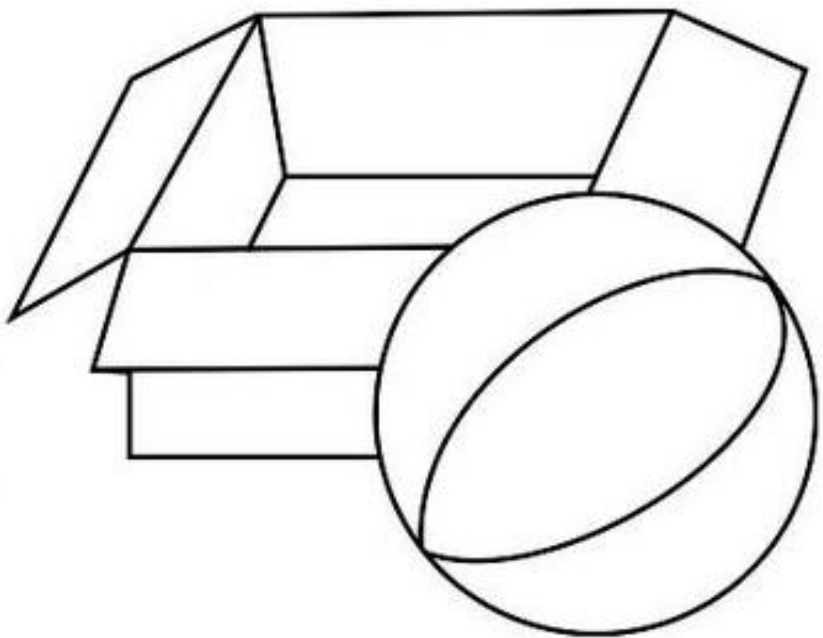

in

out



Year 1 Week 9 Day 1



Name: _____

Instructions: Look at the pictures. Put an \checkmark in the box answer the questions.

Which picture shows the duck is **in** the circle?

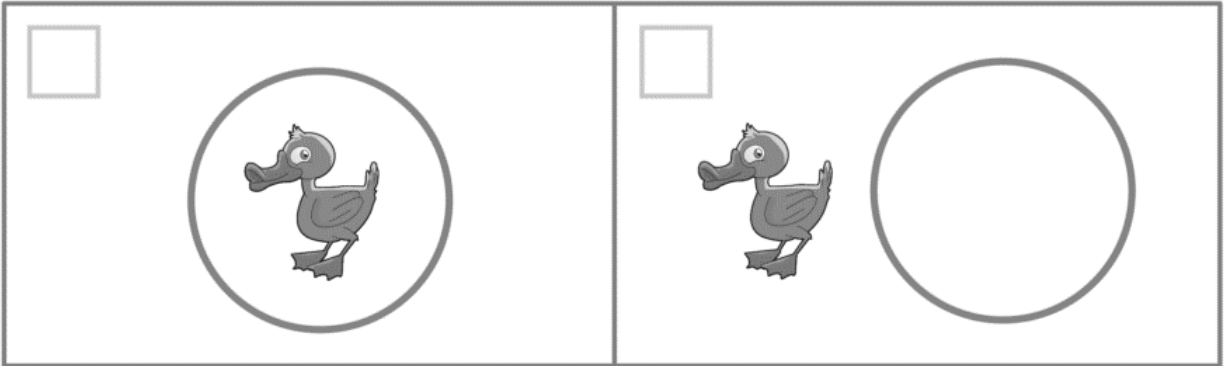

Which picture shows the crab is **out** of the square?

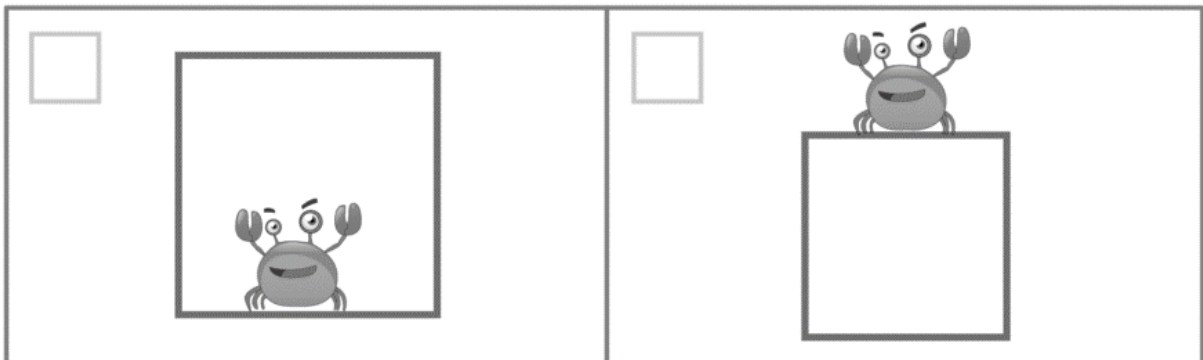

Which picture shows the lizard is **out** the triangle?

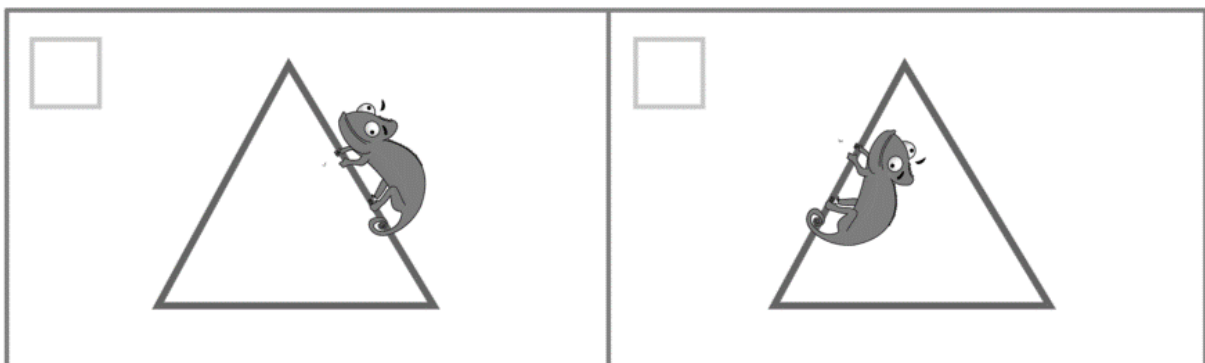

Name: _____

Instructions: Cut and paste seven sweets **in** the jar and two sweets **out** the jar.



Year 1 Week 9 Day 4

Name: _____

Cut and paste pictures for Year 1 Week 9 Day 4 activity.

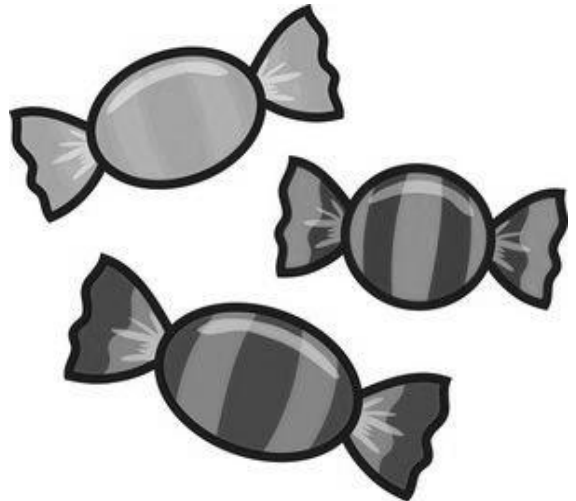
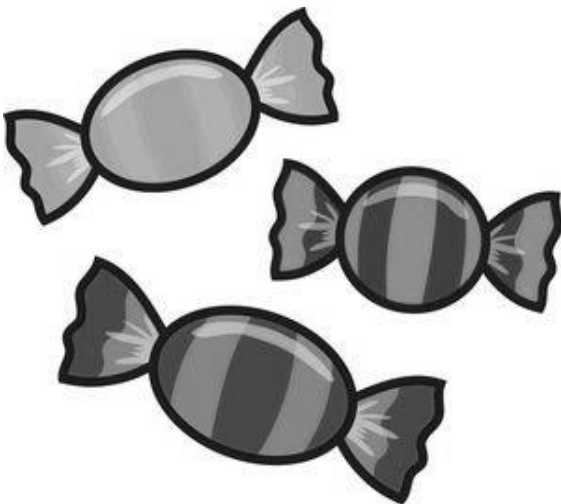
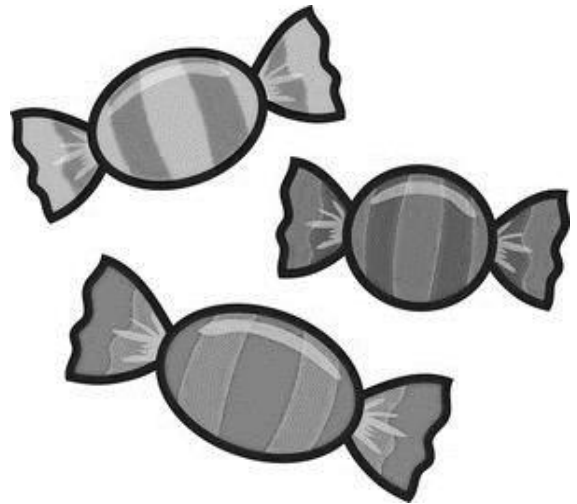
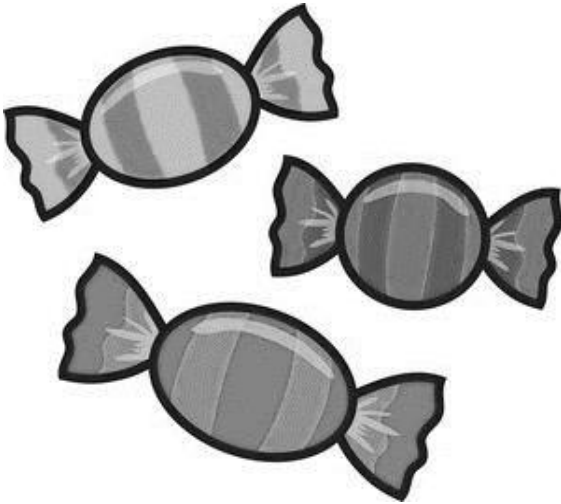

Name: _____

Instructions: Look at the words "in" and "out" below. Trace the words then practice reading the words.



in

in



out

out



The



is

in

the tub.



The



is

out

the tub.

Name: _____

Instructions: Put an X on the items that should go **in** the pencil case.

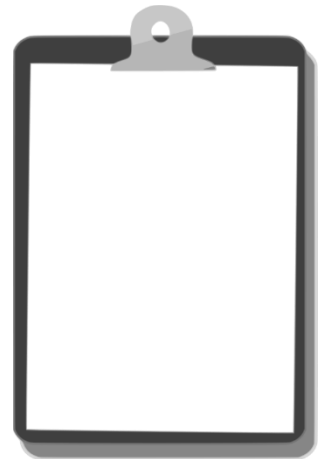
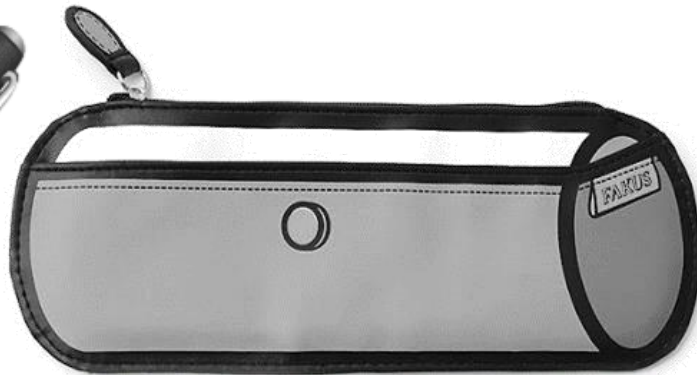
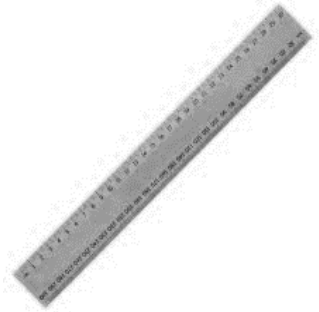
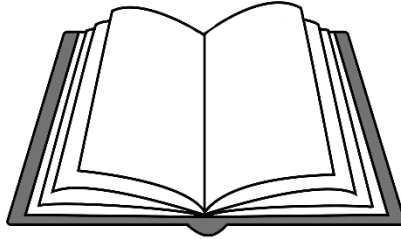

Year 1 Week 9 Day 4

Name: _____

Instructions: Draw fruits to show **in** and **out** the bowl.

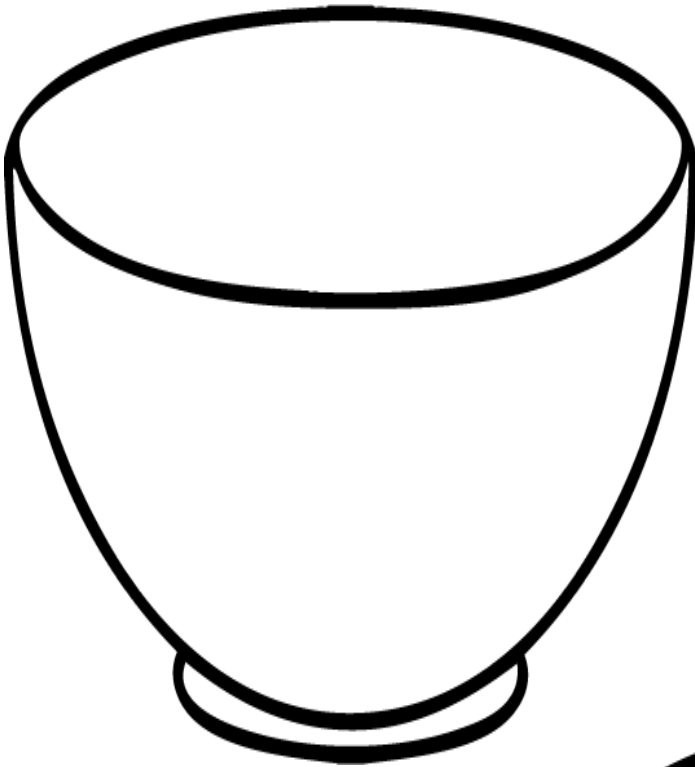

out

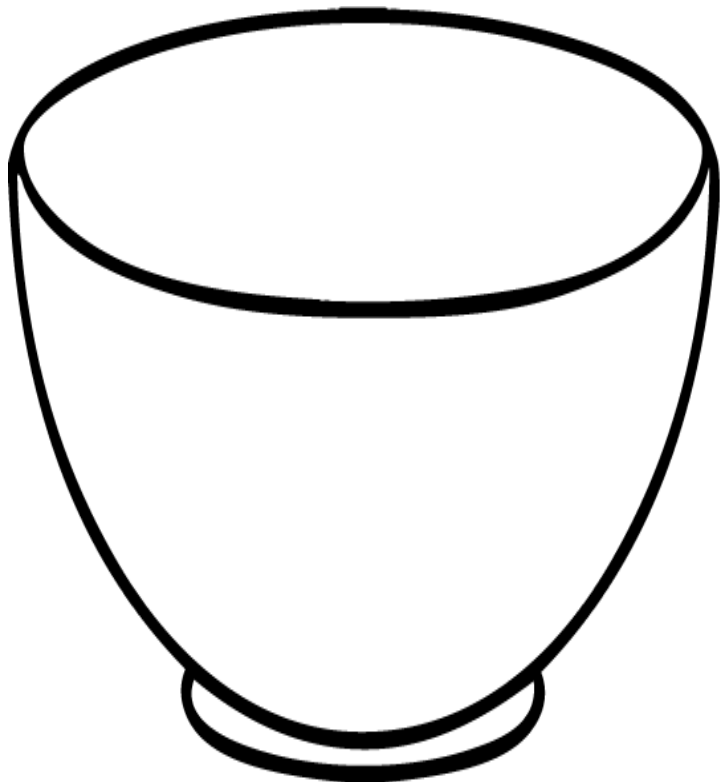

in

Name: _____

Instructions: Join the dots to put the dog **in** the kennel. Colour the picture.

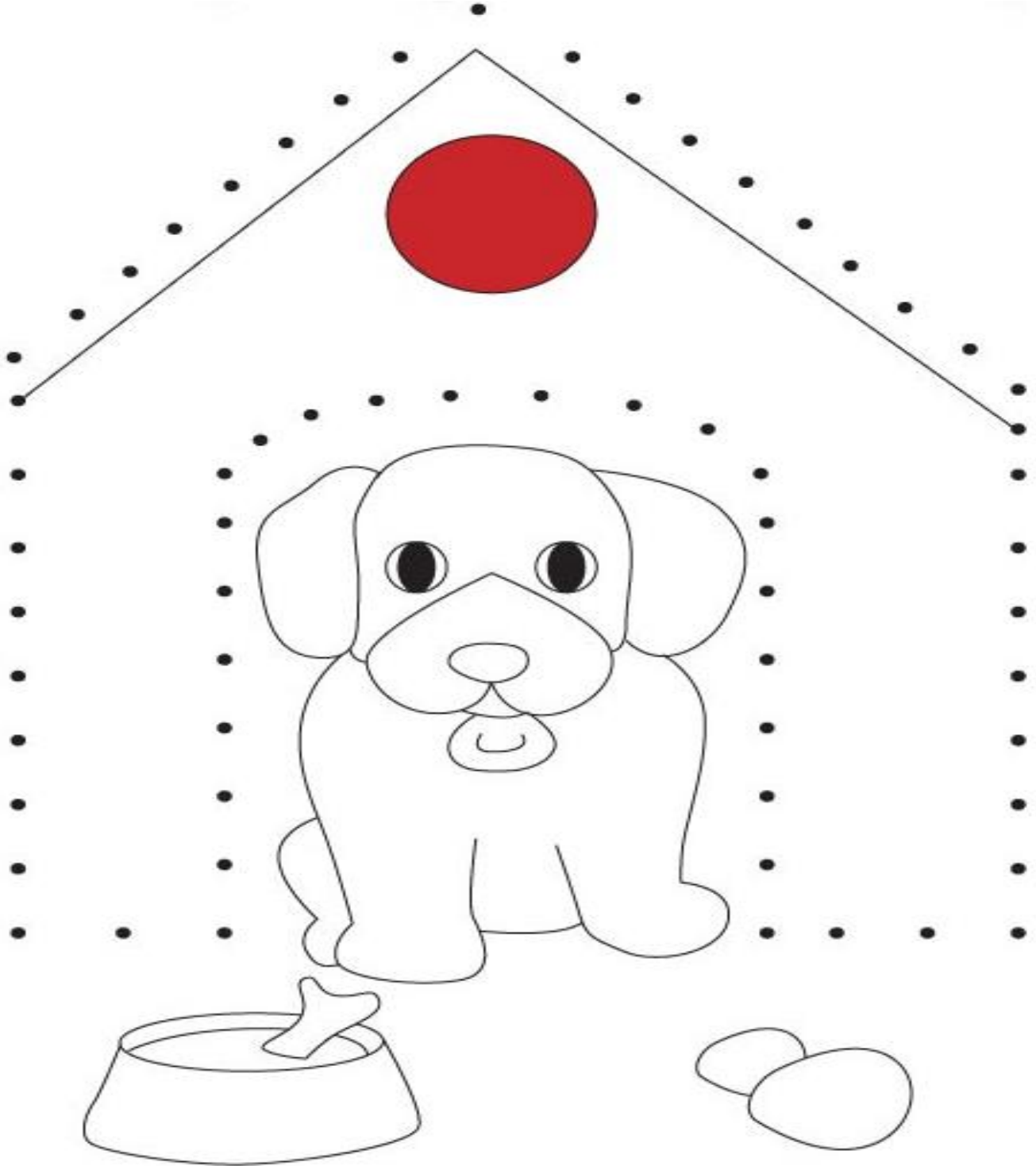

Year 1 Week 9 Day 5